

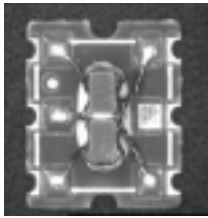

E-Series 75 Ohm Coupler 5 - 1000 MHz

Features

- Coupling 17db Typical
- Surface Mount
- Tape and Reel Packaging available



SM-55 Package

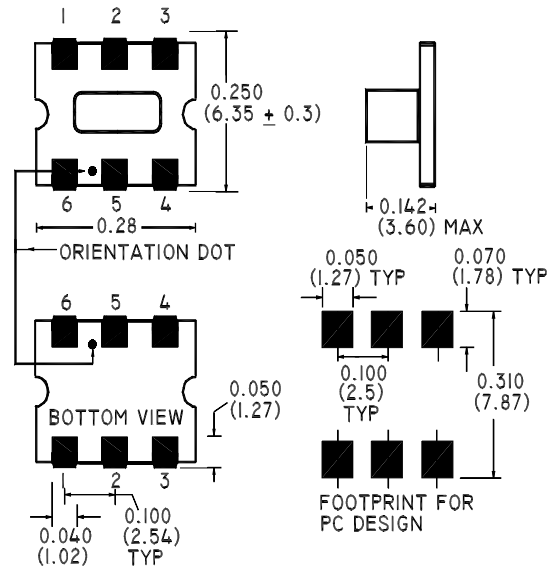

Description

M/A-COM's ELDC-17 is a high performance 75 Ohm Coupler, in a SM-55 low cost, surface mount package. The ELDC-17 is designed for use in high volume CATV applications. Typical applications include Set-top Boxes, Network Interface Units, Cable Amplifiers and Headend equipment.

Electrical Specifications @25°C

Frequency Range	5 - 1000 MHz	Units	Nominal	Typical	Minimum	Maximum
Mainline Loss	5 - 860 MHz	dB	—	0.5	—	1.0
	870 - 1000 MHz	dB	—	0.6	—	1.2
Coupling	5 - 860 MHz	dB	17.2	—	—	± 0.7
	860 - 1000 MHz	dB	17.0	—	—	± 0.8
Coupling Flatness		dB	—	—	—	1.0
Directivity	5 - 50 MHz	dB	—	40	30	—
	50 - 500 MHz	dB	—	22	16	—
	500 - 1000 MHz	dB	—	12	8	—
Input Return Loss	5 - 50 MHz	dB	—	25	20	—
	50 - 500 MHz	dB	—	23	20	—
	500 - 1000 MHz	dB	—	25	20	—
Output Return Loss	5 - 50 MHz	dB	—	29	20	—
	50 - 500 MHz	dB	—	26	23	—
	500 - 1000 MHz	dB	—	28	23	—
Coupled Return Loss	5 - 50 MHz	dB	—	25	20	—
	50 - 500 MHz	dB	—	24	20	—
	500 - 1000 MHz	dB	—	24	20	—

Please Note that the photograph above indicates package shape only, unit may be wired differently.

S 1387 D



M/A-COM Division of AMP Incorporated ■ North America: Tel. (800) 366-2266, Fax (800) 618-8883 ■ Asia/Pacific: Tel. +85 2 2111 8088, Fax +85 2 2111 8087 ■ Europe: Tel. +44 (1344) 869 595, Fax+44 (1344) 300 020

www.macom.com

AMP and Connecting at a Higher Level are trademarks.
Specifications subject to change without notice.

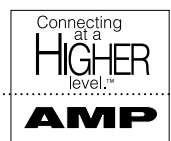

Operating Characteristics

Function	Pin No.
Input	6
Output	1
Coupled	4
Ground	5
Not Connected	2
External 75 Ohms	3

Absolute Maximum Ratings

Parameter	Absolute Maximum
RF Power	250 mW
DC Current	30 mA
Pin Temperature (10 sec)	260°C
Operating/Storage Temperature	-40°C to +85°C

Typical Performance @ 25°C

Mainline Loss

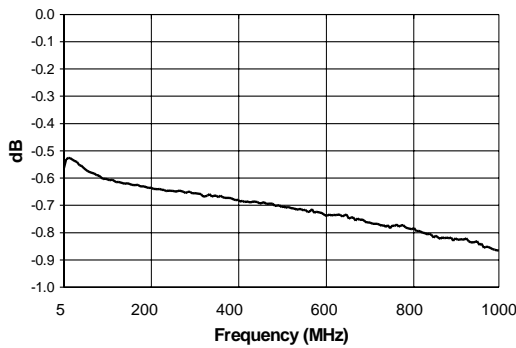

Input Return Loss

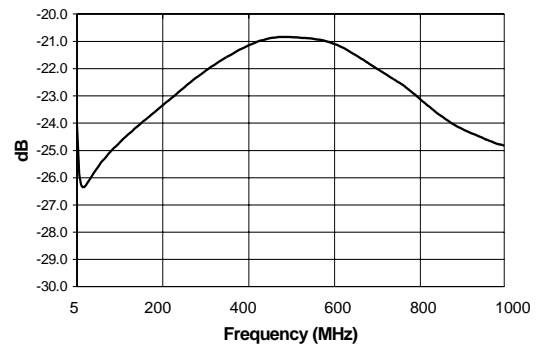

Coupling

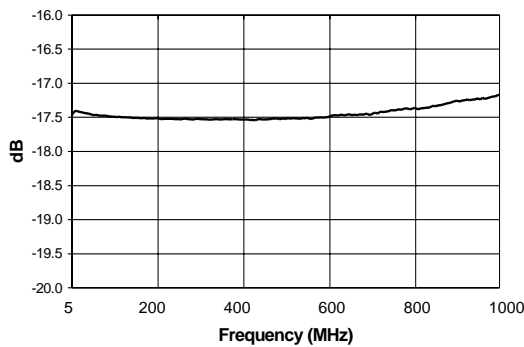

Output Return Loss

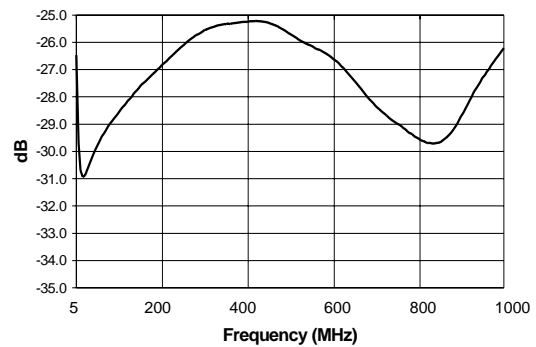

Directivity

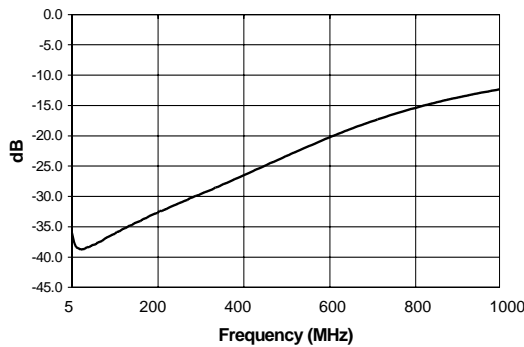

Coupled Port Return Loss

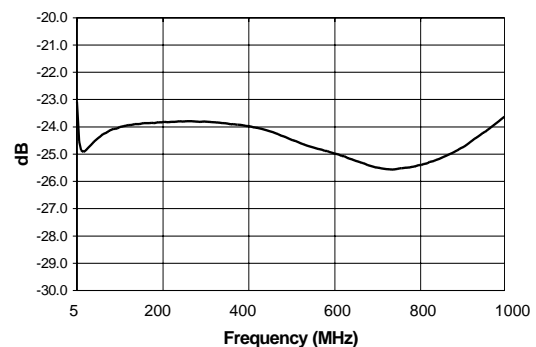

S 1387 D



M/A-COM Division of AMP Incorporated ■ North America: Tel. (800) 366-2266, Fax (800) 618-8883 ■ Asia/Pacific: Tel. +85 2 2111 8088, Fax +85 2 2111 8087 ■ Europe: Tel. +44 (1344) 869 595, Fax+44 (1344) 300 020

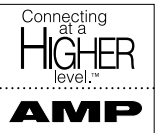

www.macom.com

AMP and Connecting at a Higher Level are trademarks. Specifications subject to change without notice.